

ATOMIC ENERGY EDUCATION SOCIETY

Turamdih Jamshedpur-832107

Academic year :2023-2024

Balvatika-2

Subject- English

Worksheet-1

Name- _____

Date : _____

1.Circle the correct letter for the given object

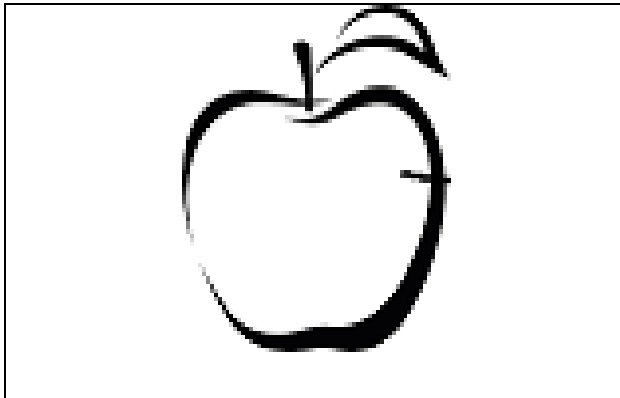

V	A	H
---	---	---

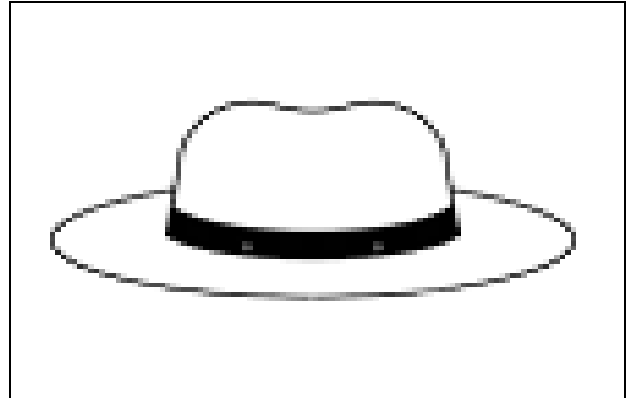

F	I	H
---	---	---

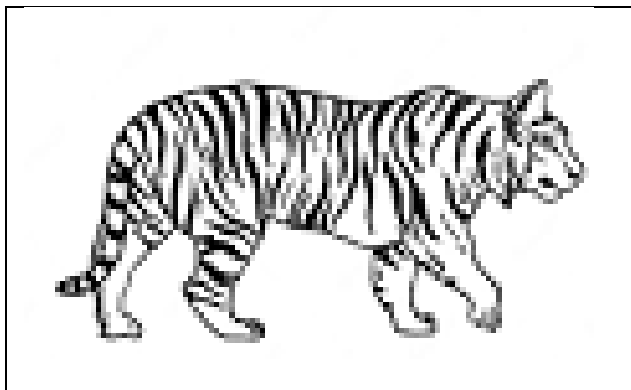

T	E	H
---	---	---

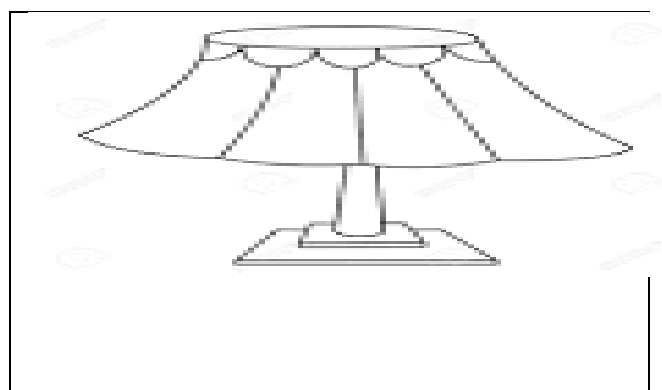

I	L	F
---	---	---

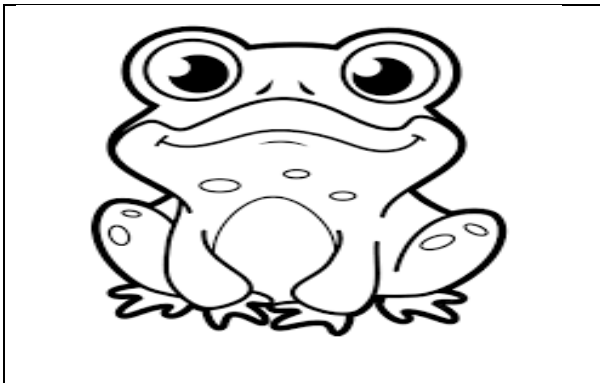

F

A

T

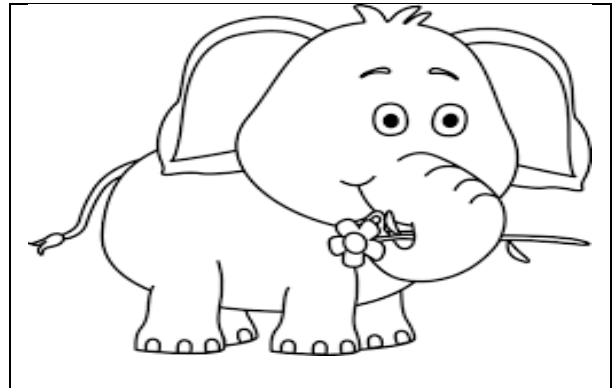

F

E

W



I

E

T

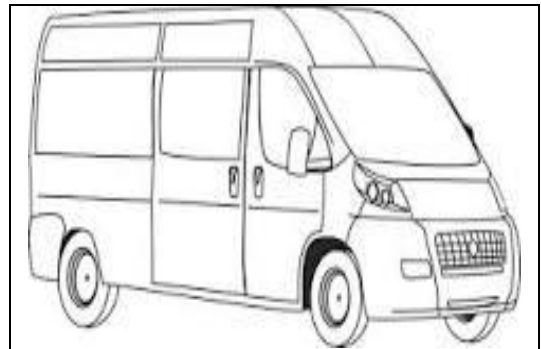

W

V

T



I

E

W

ATOMIC ENERGY EDUCATION SOCIETY

Turamdih Jamshedpur-832107

Academic year :2023-2024

Balvatika-2

Subject- English

Worksheet-2

Name- _____

Date : _____

1. Write the the first letter of the given object .

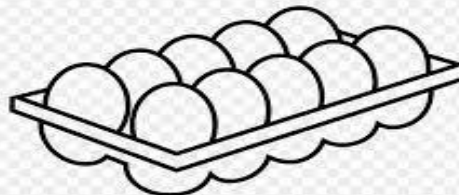
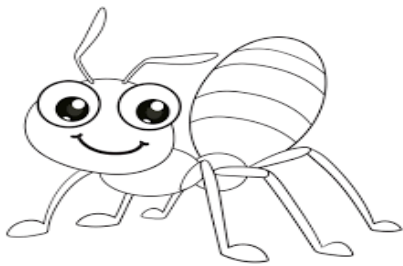

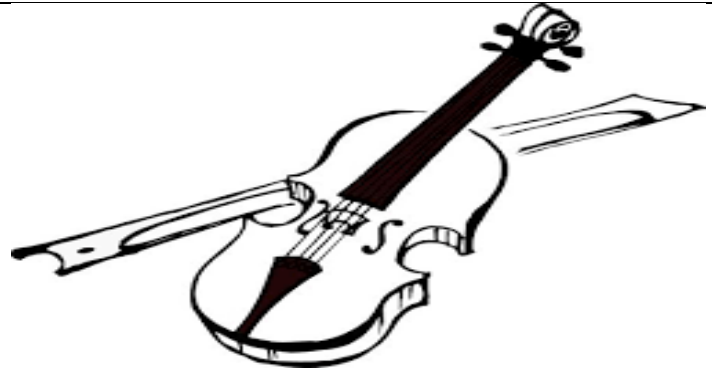
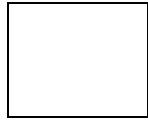

dreamstime.com

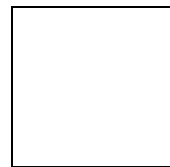

ATOMIC ENERGY EDUCATION SOCIETY

Turamdih Jamshedpur-832107

Academic year :2023-2024

Balvatika-2



Subject- English



Worksheet-3

Name- _____

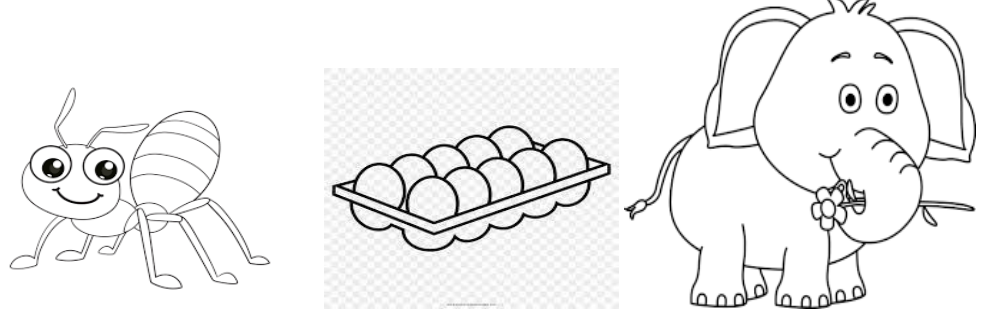
Date : _____

1.Colour the correct picture for the given letter.

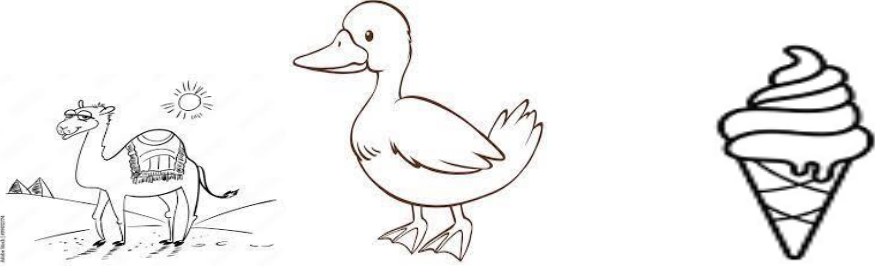
	<p>A</p>
	<p>E</p>
	<p>F</p>
	<p>H</p>

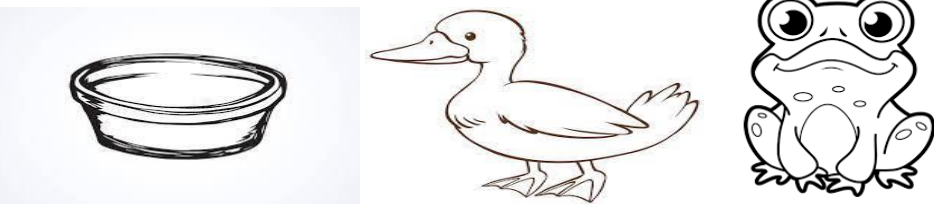
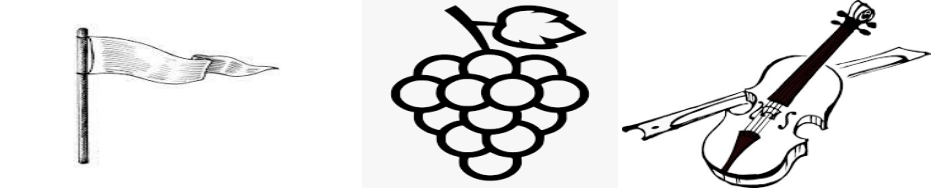
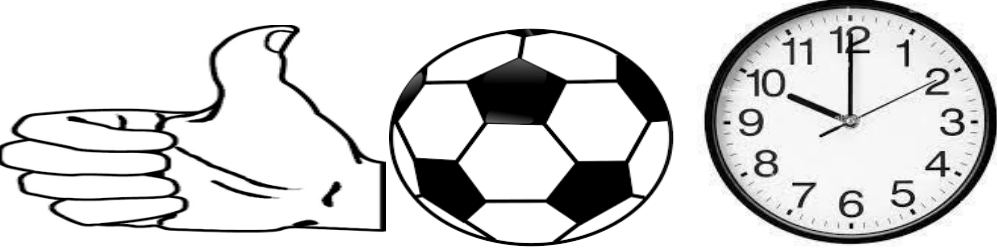
	<p>I</p>
	<p>L</p>
	<p>T</p>
	<p>V</p>
	<p>W</p>

ATOMIC ENERGY EDUCATION SOCIETY

Turamdih Jamshedpur-832107

Academic year :2023-2024

Balvatika-2

Subject- English

Worksheet-4

Reading comprehension

Name- _____

Date : _____

First, trace each sentence. Next, read each aloud. Then, draw a line to match the sentence to the correct picture

DON'T PULL THE PLUG

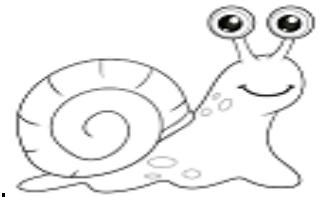

BHAVYA WAVED THE
FLAG



THE SNAIL MOVES VERY
SLOWLY.



I USE MY HAND TO CLAP

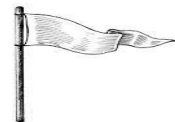

HE CAUGHT A HUGE FISH

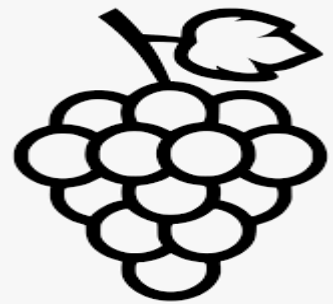

THE SPIDER SPINS ITS
WEB.



I LIKE TO EAT GRAPES.

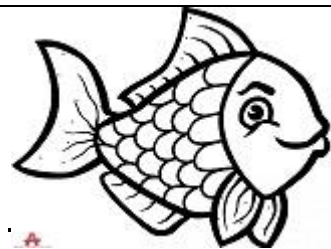

PLEASE SIT ON THE
CHAIR.

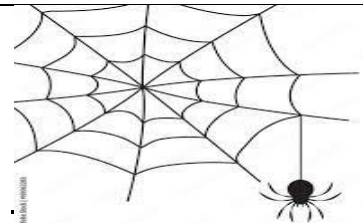

ATOMIC ENERGY EDUCATION SOCIETY

Turamdih Jamshedpur-832107

Academic year :2023-2024

Balvatika-2

Subject- English

Worksheet-5

Myself

Name- _____

Date : _____

ALL ABOUT ME

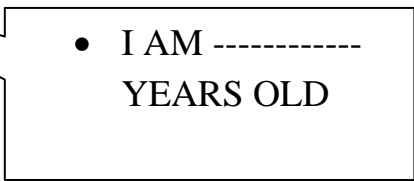
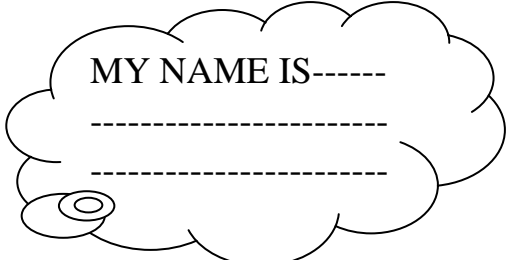
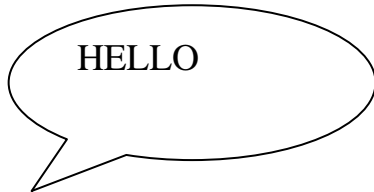

MY FREE TIME ACTIVITY IS

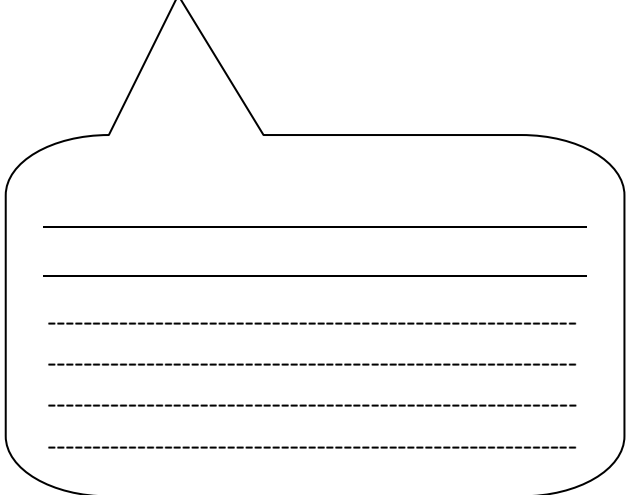

MY FAVORITE FOOD IS



pixta.jp - 50854384